

Violle



profim



"The line between work and leisure is becoming increasingly blurred. The office is no longer purely a working space, but an integral part of our living environment. Violle embraces this shift by bringing a soft, warm and residential character to the office."

Christopher Schmidt
Product Designer, ITO Design



Violin | *vi·o·lin* | *noun*

A string musical instrument, tuned in fifths in the range of G to E, usually encompassing more than four octaves, with a shallow resonance box, a non-threshold fingerboard ending in a spiral head and a curved bridge.

Violle | *vi·o·lle* | *noun*

Modern office chairs inspired by the timeless beauty of the violin. Created without compromise, with attention to every detail to provide maximum comfort and pleasure. The highest quality captured in an elegant form.



Timeless design



Violle was inspired by the violin – its perfect, well-crafted lines, with every detail playing specific role. All elements of both the violin and the Violle serve a single purpose – to achieve the highest degree

of functionality. The timelessness of the chairs is rooted in their pure form, which is the result of evolutionary changes determined not only by aesthetics, but above all by practical considerations.

We can work comfortably and efficiently anywhere, both in the office at at home. Violle combines ergonomically advanced solutions with an attractive design to fit any interior.





Beauty
is not created
overnight.



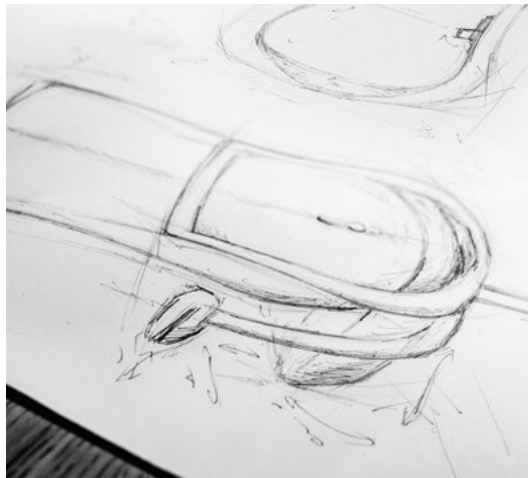
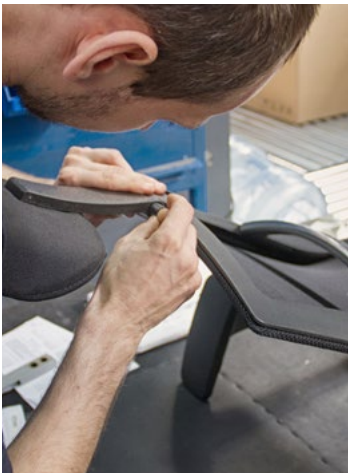

In the beginning there was an idea.

The idea was to create a product that would be both attractive and functional, both advanced and easy to use. One that would provide significant comfort. The concept was followed by hard work – endless conversations, stacks of sketches, consultations, subsequent prototypes. All our effort meant we didn't have to compromise on anything. That's why we're proud to present the Violle chair – an idea that has become a reality.





The combination of luxury and classic style means that Violle can successfully play first violin in the manager's office. A comfortable headrest, adjustable armrests with soft padding, and stylish leather upholstery underline the exclusive character of the chair.



Easy adjustments

The levers are intuitive to use and take into account the needs of all users. The frame is embossed in Braille to allow people with visual impairment to use all the chair's functions.

Full control at arm's length

Violle is a carefully designed product in which practicality and aesthetics play equal roles. The entire adjustment mechanism is concealed under an attractive cover. The levers are positioned underneath the seat for ergonomic use – they're easily accessible but don't interfere with the chair's harmonious and elegant silhouette.



The levers integrated in the seat ensure quick and easy adjustment.

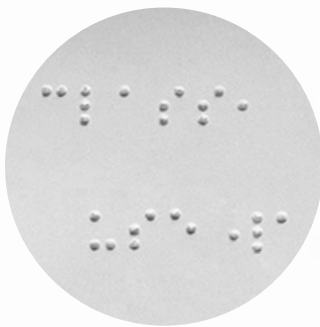

Braille embossing is a practical convenience for the blind and visually impaired.



Fully adjustable lumbar support maximises user comfort.

Violle is a beautiful and accessible vision of the future – a vision of office spaces that are both stylish and practical. The chair's modern, clean lines, ideal proportions, and refined materials make Violle a thing of beauty.





Ergon

At



09:00

Good morning

You have a busy day ahead. Adjust your chair as best you can, that way you can stay focused on the task at hand.

- Adjust the correct seat height
- Adjust the seat depth to your height
- Adjust the armrest height



11:00

During meetings

Be active both in the meeting and in the chair. Take advantage of the flexibility it offers.

- Adjust the tilting force of the backrest to your size, ensuring the chair responds gently to your movements.
- Hang your jacket on the hanger

omics

any time



14:00

Full concentration

It's time to focus on your work. Violle will make it easier for you.

- Use the additional tilt function of the backrest and seat
- Lock the backrest – you have 5 options for adjusting the backrest angle
- Adjust the lumbar support to relieve the strain on your lumbar spine



17:00

A moment for yourself

Relax at the end of a busy and effective day.

- Release the Synchro mechanism – free tilt will stimulate your activity
- Use the adjustable headrest to relieve strain on the cervical spine

With a four-legged aluminium base, the Violle conference models are a comfortable and stylish way to organise your meeting. With a memory function which automatically returns the chair to its original position, Violle is always ready for a new meeting, and it's easier to keep the room looking neat and tidy.







In harmony with every interior

The Violle chair is available in an extremely wide range of finishes and fabrics, allowing you to customise the chair to suit both your needs and the interior space.





The backrest of the chair can be upholstered with fabric or made of light, breathable mesh. Each solution will pass the test in both office spaces and home offices.



Configure your product

When ordering, please use code symbols.





Violle









Backrest

Base /
Mechanism

Base colour

 <p>Upholstered</p> <p>130</p>	 <p>Upholstered, with headrest</p> <p>131</p>
 <p>Mesh</p> <p>150</p>	 <p>Mesh, with headrest</p> <p>151</p>

 <p>Swivel, 5-star base, SFL mechanism</p> <p>SFL</p>
 <p>Swivel, 4-star base</p> <p>F</p>

 <p>BLACK ¹</p>	 <p>RAL 7047 ¹ Light grey</p>
 <p>RAL 9016 White</p>	 <p>GRAPHITE</p>
 <p>POLISHED ALUMINIUM</p>	

¹ Applicable for SFL version.

² Aluminium elements: armrest frame, backrest frame.

³ Plastic elements: seat cover+adjustments levers, outer frame in mesh backrest, lumbar support, rear part of headrest.

⁴ Applicable for F version.

⁵ In models Violle 130F:

- cover colour light grey – base metallic, white and polished aluminium,
- cover colour black - base graphite.

In models Violle 150F:

- cover colour always the same as frame of backrest.

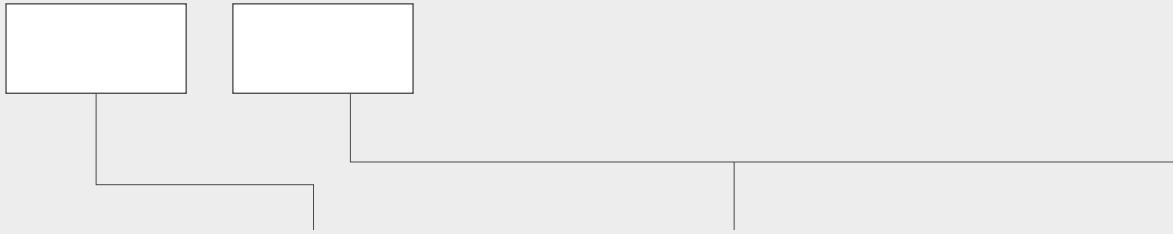

Armrests ¹

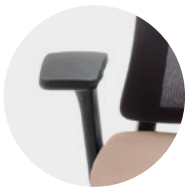

Adjustable armrest

Height adjustable armrest (90 mm), sliding soft pad (± 50 mm) with span option (± 28 mm).

P62PU



Adjustable armrest

Height adjustable armrest (90 mm), sliding soft pad (± 50 mm) with span option (± 28 mm).

P62PU

Upholstery

Type & colour

SYMBOL

Mesh



RH-17



RH-15



RH-16



RU-17



RU-15



RU-16



TN-16

Additional

Plastic elements ^{1, 3, 5}



RAL 7047

Light grey



BLACK

Aluminium elements ^{1, 2, 4}



RAL 9016

White



GRAPHITE



POLISHED

Castors / Glides ¹



HARD

For soft floors.



SOFT

For hard floors.



TEFLON

Universal.

Castors are equipped with a brake that prevents the chair from "moving away" without a load. Castors colours: black or light grey.

Glides ⁴

HARD

For soft floors.

FELT

For hard floors.

TEFLON

Universal.

Lumbar support

Applicable for SFL version.



Gaslift with memory without height adjustment

Applicable for F version.



Hanger

Colours: black or light grey.



HA

Measurements

The measurements are approximate and can differ depending on the product configuration.
 Measuring methodology is available at this link: www.profim.eu/Measuring_methodology.pdf

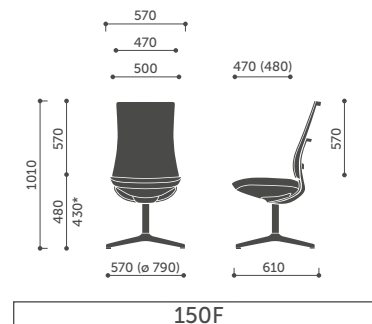
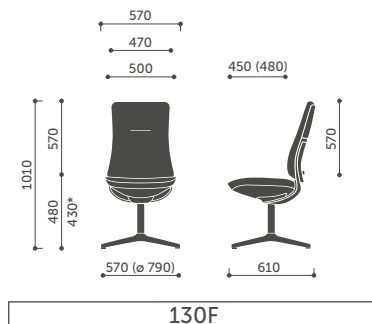
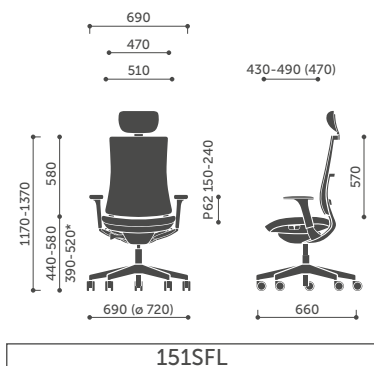
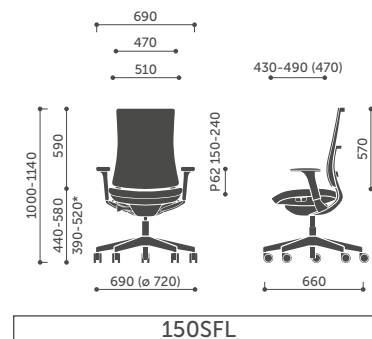
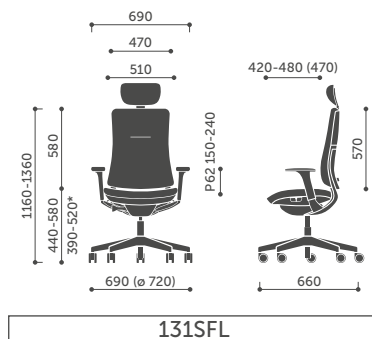
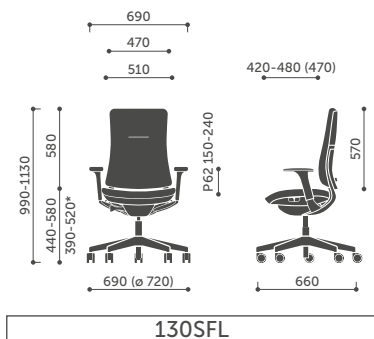

* Seat height is measured according to PN EN 1335-1 norm (with seat burden).



Profim and the Environment

In our operation we follow the sustainability principle. We operate in a responsible manner for the benefit of our customers, employees, suppliers, and the local community, but we always respect the environment.

In order to achieve our goals, we have implemented Environmental Management System based on the ISO 14001 standard, which allows for a comprehensive approach to ecology. We take into consideration and evaluate the way Violle products affect the environment during their entire life cycle.

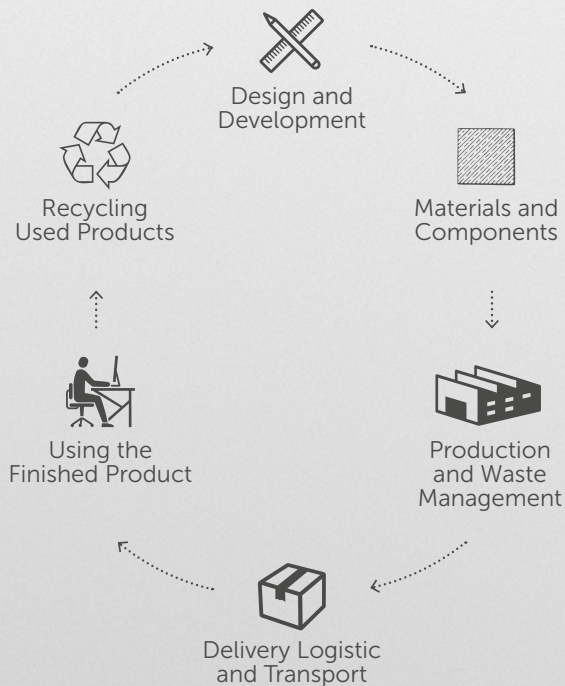

For more information about the product please scan the QR code.

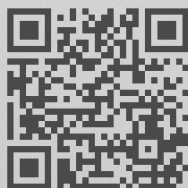

Violle

Product Environmental Information

(for Violle 150SFL Black P62PU)

Materials used:

Metals	kg	%
Steel	6.50	35.6
Aluminium	4.14	22.6
Plastics	kg	%
Polyamide (PA)	5.40	29.5
Polypropylene (PP)	0.82	4.5
Polyurethane (PUR)	0.82	4.5
Other	kg	%
Upholstery	0.60	3.3
Weight	18.28	100.0

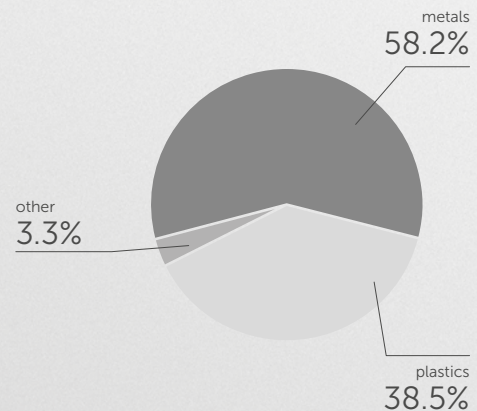

This product contains no chemical compounds harmful to human health or the environment (including PVC, chromium (VI), mercury or lead).

www.profim.eu

The producer reserves the right to conduct construction changes and improvements of the products.
Colours presented in the catalogue may vary from the original colours of furniture.



CHROMIUM (III)
Eco-Friendly Technology

CHROM (III)
Umweltfreundliche
Technologie

